



# Panel/Door/Panel with 90° Panel

## 1951, 1952

**Preceria** 5/16" Frameless  
Straight or Curved Door

Please refer to page 16 of the Full Line Catalog for illustrations and additional information.

Unit No.	Centerline up to:	Height	Glass Selections	Glass Code	Silver	Trends	Colours
1951	60" x 48"	74"	Clear	CL	1788	2328	2453
			Silk	LK	2789	3330	3455
			Silk/Clear <i>(Silk Panels only, Door remains clear)</i>	KK	2530	3070	3195

1952	60" x 48"	74"	Clear	CL	2106	2646	2771
			Silk/Clear <i>(Silk Panels only, Door remains clear)</i>	KK	2848	3388	3513

*\*Please note: Threshold must be a minimum width of 4" with sufficient structure underneath curb for mounting screws. For curved threshold, please see curved threshold mold (1900) below or request a curved template (1999) to ensure appropriate shape is achieved.*

Fiberglass Threshold Mold							
1900	28 <sup>3</sup> / <sub>8</sub> " Unfinished <b>Curved</b> Threshold for Tile or Surface Application					\$233	
1999	Plastic pattern to create curve					\$20	

Details & Options	
	Standard 28" door is centered between panels unless otherwise specified. Minimum Hinge Panel size is 6 <sup>5</sup> / <sub>16</sub> ". Minimum Strike Panel size is 3 <sup>5</sup> / <sub>16</sub> ". Maximum total opening width is 60" x 48"
	For any variation to standard sizes, add \$318.00 to 1951 list price. 1951 (straight) doors may be customized up to 28" wide with a maximum height of 84". 1952 (curved) doors cannot be customized.
	<b>Notched Panel</b> - add \$114.00 to list. Notched panels can exist on either or both sides as long as minimum panel width guide lines are met ( <i>see above</i> ).
	For <b>out of square conditions</b> greater than 5/16" on the walls or threshold, add \$100.00 per stationary panel affected.
	Preceria's unique elliptical shaped Header System, Hinges, and Handle are exclusively designed for 5/16" glass and are not available for other units.
	To add <b>AquaGlide™</b> Protection, prefix the unit number with the letters (AG) and add \$309.00 list.

### Notes

Ordering Example
1951LKOR (Unit number, followed by glass selection code, then by frame color code.)

### Frame Selection Codes

Anodized Finishes			
Silver	No Code		
Trends			
Brushed Nickel	BN	Oil Rubbed Bronze	OR
Antique Pewter	QP	Satin Nickel	SN
Colours			
Almond	AP	Burnished Copper	CU
Bronze	BR	White	WP
Brushed Bronze	BB	Wrought Iron	WI

# Celesta Hinges

Wall Mount Hinge

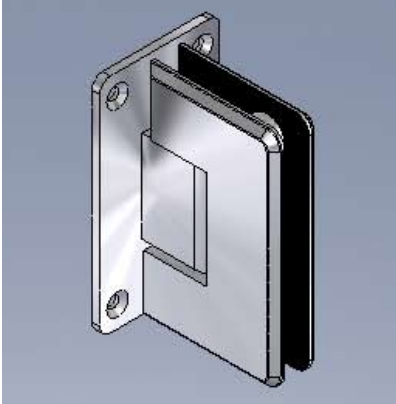

Wall Mount Pivot Hinge



Top or Bottom Mount Hinge



## Hinge Selection Guidelines

Hinge Series	Qty.	Glass Thickness	Max. Door Panel Width	Max. Door Panel Weight
Wall Mount	2	3/8" or 1/2"	28"	80 lbs.
Wall Mount	3*	3/8" or 1/2"	36"	120 lbs.
Pivot	2	3/8"	31"	100 lbs.
Pivot	2	1/2"	36"	145 lbs.

To calculate glass weight, multiply width x height and divide by 144, then multiply by either 5 lbs. (3/8" glass ) or 6.5 lbs. (1/2" glass).

Height restrictions will exist due to weight capacity of the hinge. Please contact Celesta Customer Service, 800-45-BASCO (800-452-2726) for height capabilities for your application.

*\*Add \$150.00 to list price for 3rd hinge.*

# Glass Clamps & Vinyl Seals

## Glass Clamp

Oversized Fixed Panel U-Clamp

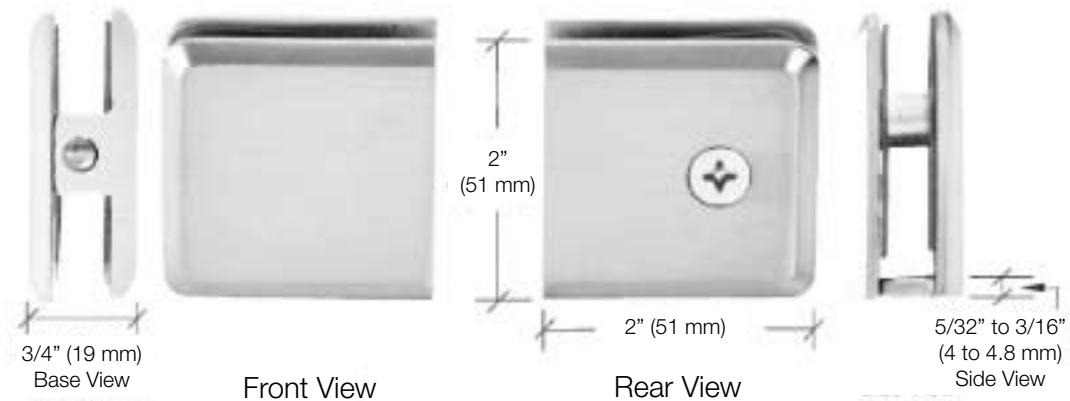

## Vinyl Seals

Included with Celesta units. If additional seals are requested, see pricing below.

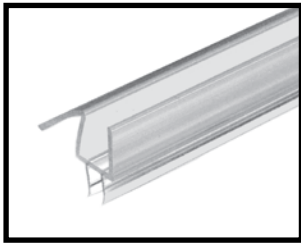

Bottom Wipe with Drip Rail  
SCV920 (3/8") - \$37.25 List  
SCV918 (1/2") - \$42.54 List

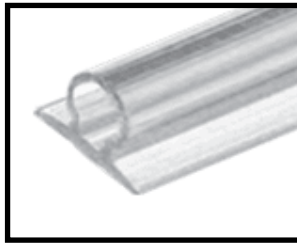

Bulb Seal  
SCV297 - \$8.83 List

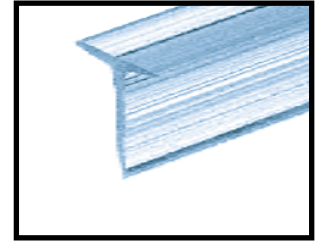

Edge "T" Wipe  
SCV933 - \$8.83 List

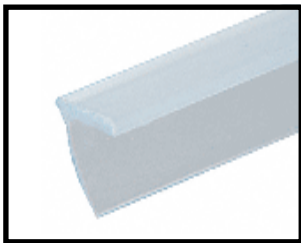

Edge "V" Seal  
SCV932 - \$8.83 List

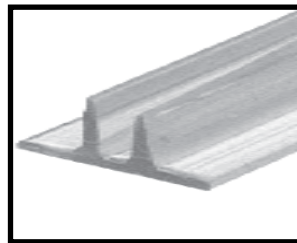

"Double Fin" Seal  
SCV928 - \$19.59 List

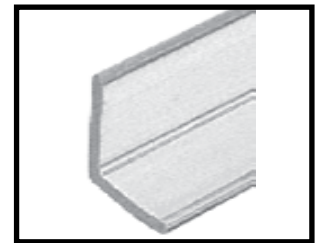

Angle Jamb  
SCV906 - \$22.13 List

### Optional\* Seal

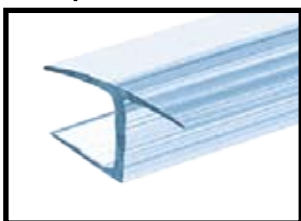

SCV913 - \$27.56 List

\*Optional - Not included with standard Celesta unit.  
Required for swing out only application.

## Answers To

# Frequently Asked Questions

1. The **maximum width of a stationary panel** that is not either secured by a header or mounted from floor to ceiling is 30".
2. When using **transom clamps**, maximum transom panel size is 30" W x 12" H. Any fixed panels must be at 180° or 135° to the transom. Walls must be 90° to the transom. With Prima transom hinges, maximum transom panel size is 36" W x 24" H. Any fixed panels must be at 180° to the transom. Walls must be 90° to the transom.
3. The **maximum width and height** for each glass type is as follows:

> Clear .....	86" W,	115" H	> Arctic Frost.....	58" W,	80" H
> Rain.....	58" W,	80" H	> Symmetry.....	58" W,	80" H
> Venetian .....	58" W,	80" H	> Silk .....	58" W,	115" H
> Cobblestone.....	58" W,	80" H			
4. The **minimum panel width** is 3" for clear glass, 5" for all other patterns. The **minimum panel height** is 17".
5. A **header must be used** if:
  - a. glass to glass hinges are incorporated and the panel is not mounted from floor to ceiling.
  - b. a fixed panel is not mounted from floor to ceiling and it exceeds a 30" centerline width.
6. **Backing material (wall reinforcement) is required at the installation position for each hinge.**
7. **Fiberglass** and **acrylic bases** or modules can only accommodate 1/4" glass, due to a lack of backing material or reinforcement. Clear 1/4" glass is \$53.68/sq. ft (list). To figure square footage price, multiply Length x Width and divide by 144, then multiply by \$53.68.  $(L \times W / 144) \times \$53.68 =$  base price. Adders for color, glass, notches, etc. are found on each model's page. Contact Customer Service for additional information.
8. To **calculate glass weight**, multiply width x height and divide by 144, then multiply by either 5 lbs. (3/8" glass ) or 6.5 lbs. (1/2" glass).
9. For **minimum notched panel requirements** see page 20.

## Celesta Warranty

Each BASCO Shower Enclosure is a custom design and undergoes several meticulous manual and automated quality control procedures. Basco offers a limited lifetime warranty against manufacturers defects.

**Glass:** All Glass is tempered and meets or exceeds all Federal Laws and specifications. All outside glass edges are polished.

**Hinges and Hardware:** Our hinges and hardware are made of the finest brass materials.

**Vinyl Gasketing:** Our clientele require that each shower expresses clean, uncluttered lines. All door openings are precision fitted, but some water may escape. With proper positioning of the showerhead the problem is usually eliminated. Vinyl gasketing is included with each door, but installation of this vinyl is optional.

Avoid using abrasives or harsh chemicals on the glass or the hardware. The usage of these materials will void the warranty. Celesta Luxury Shower Enclosures are certain to give you many years of enjoyment.

# Notch Panel Guidelines

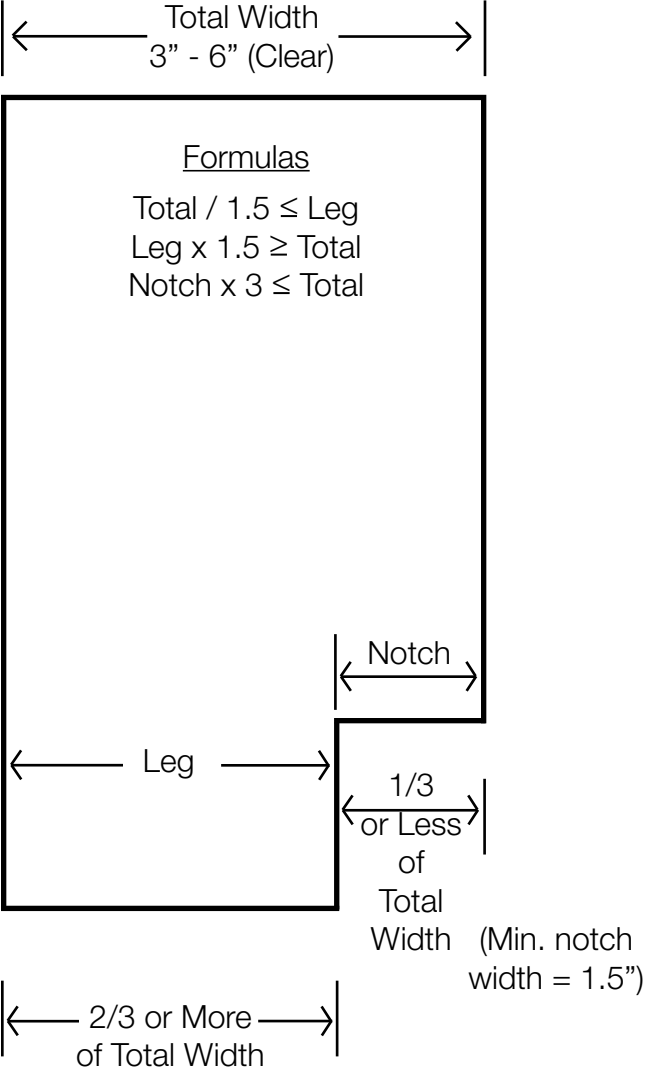
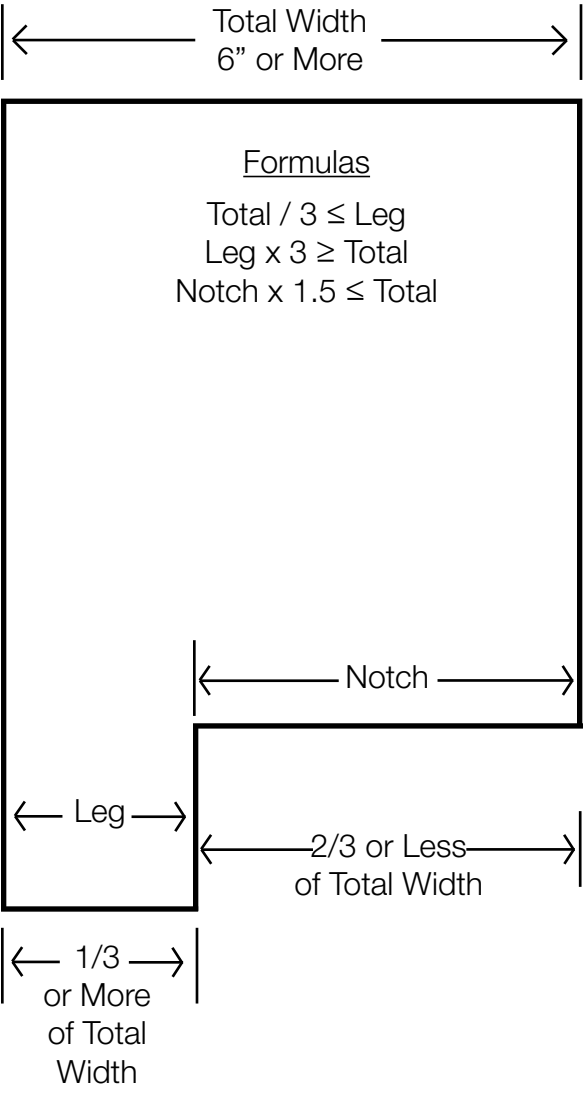

≤ Less Than or Equal To  
 ≥ Greater Than or Equal To



Shower Enclosure Drawing Area. Please provide all hinge sides, angles and out-of-plumb / out-of-level conditions to 1/16". Quote will be based on dimensions shown. Please request a re-quote if any dimensions change. Please make copies of these pages as needed for future use.

A large grid of 20 columns and 20 rows of small dots, intended for technical drawing or notes.



# Alphabetical Index

Answers to Frequently Asked Questions (FAQs).....	20	Panel/Door/Panel (1926/1927).....	16
Cambria Door Pull .....	3	Panel/Door/Panel (925/VE925).....	10
Celesta Selection Guide.....	23	Panel/Door/Panel with 90° Return (1951/1952) .....	17
Circa Door Pull .....	3	Preceria Units .....	16-17
Circa Pull & Towel Bar Set .....	6	Prestige Door Pull.....	3
Contempo Door Pull .....	3	Pull and Towel Bar Sets .....	6
Contempo Towel Bar .....	5	Sliding Tub/Shower (2850/3850).....	15
Contempo Pull & Towel Bar Set.....	6	Swing Door (900).....	7
Door and Panel with 90° Return (950/VE950) .....	13	Splash Panel (910).....	8
Door Pulls.....	3	Technique Door Pull.....	3
Door with 90° Return (945) .....	12	Technique Towel Bar.....	5
Door with Inline Panel (935/VE935).....	11	Towel Bars.....	5
Drawing Area.....	22	Vintage Door Pull.....	3
French Doors (922).....	9	Vintage Towel Bar.....	5
Glass Clamps .....	19	Vintage Pull & Towel Bar Set.....	6
Hinges.....	18	Vinyl Seals .....	19
Hinge Selection Guidelines .....	18	Warranty.....	20
Knobs .....	4	Wexford Door Pull.....	3
Neo Angle 960 .....	14	Wexford Towel Bar .....	5
Notch Panel Guidelines .....	21	Wexford Pull & Towel Bar Set.....	6

# Unit/Part Number Index

900 Celesta Swing Door.....	7	SCV918 1/2" Bottom Wipe w/ Drip Rail.....	19
910 Celesta Splash Panel .....	8	SCV920 3/8" Bottom Wipe w/ Drip Rail.....	19
922 Celesta French Doors.....	9	SCV927 Bulb Seal.....	19
925 Celesta Panel/Door/Panel .....	10	SCV928 "Double Fin" Seal.....	19
935 Celesta Door with Inline Panel.....	11	SCV932 Edge "V" Seal .....	19
945 Celesta Door with 90° Return .....	12	SCV933 Edge "T" Wipe.....	19
950 Celesta Door and Panel with 90° Return .....	13	VE925 Celesta Panel/Door/Panel .....	10
960 Celesta Neo Angle.....	14	VE935 Celesta Door with Inline Panel .....	11
1926 Preceria Panel/Straight Door/Panel .....	16	VE950 Celesta Door & Panel w/ 90° Return.....	13
1927 Preceria Panel/Curved Door/Panel .....	16		
1951 Preceria Pnl/Straight Door/Pnl, 90° Return .....	17		
1952 Preceria Pnl/Curved Door/Pnl, 90° Return .....	17		
2850 Celesta Sliding Tub .....	15		
3850 Celesta Sliding Shower.....	15		
SCV906 Angle Jamb .....	19		
SCV913 Optional "H" Jamb.....	19		



7201 Snider Road  
 Mason, OH 45040  
 800.45.BASCO (800.452.2726)  
 888.405.2726 fax